



The Rise of IP in Remote Production Networks

Carl Petch, Principal Solutions Architect
Telstra



IP SHOWCASE THEATRE AT IBC2019 : 13-17 SEPT 2019



20,000-Kilometer Remote Production Breakthrough



ITN coverage of IAAF World Relays 2019 in Yokohama Japan



IP SHOWCASE THEATRE AT IBC2019 : 13-17 SEPT 2019



Un-compressed

TIny COdec (TICO)

Light Compression
 Process of initial Quantization of YUV
 (Video +Audio) Then TIC Compression
 Very Low Latency/Lossless Quality
 TICO Alliance/SMPTE as RDD35
 Up to 4:1
 Built for IP-High Bit Rate /
 HD/UHD/4k/3G-SDI

Uncompressed
 Zero Compression Latency
 Original Uncompromised Quality

VC-2 Compression

Intra-Frame
 Wavelet Transform Encoding
 Low Latency
 (BBC-R&D) SMPTE ST 2042-1
 2:1 or 4:1 compression
 Built for IP Networks High Bit Rate
 HD/UHD/4k/3G-SDI

IP SHOWCASE THEATRE AT IBC2019 : 13-17 SEPT 2019



20,000-Kilometer Remote Production Breakthrough (Un-compressed)

IP SHOWCASE THEATRE AT IBC2019 : 13-17 SEPT 2019

XF Transmission
Communication Protocol
between Camera and XCU

20,000-Kilometer Remote
Production Breakthrough
(Un-compressed)

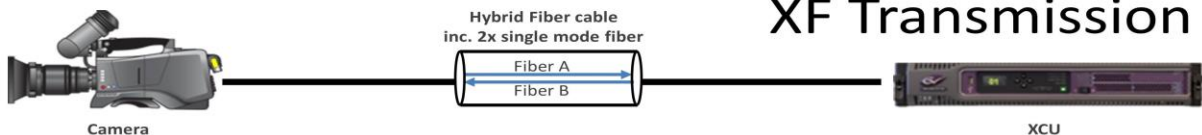
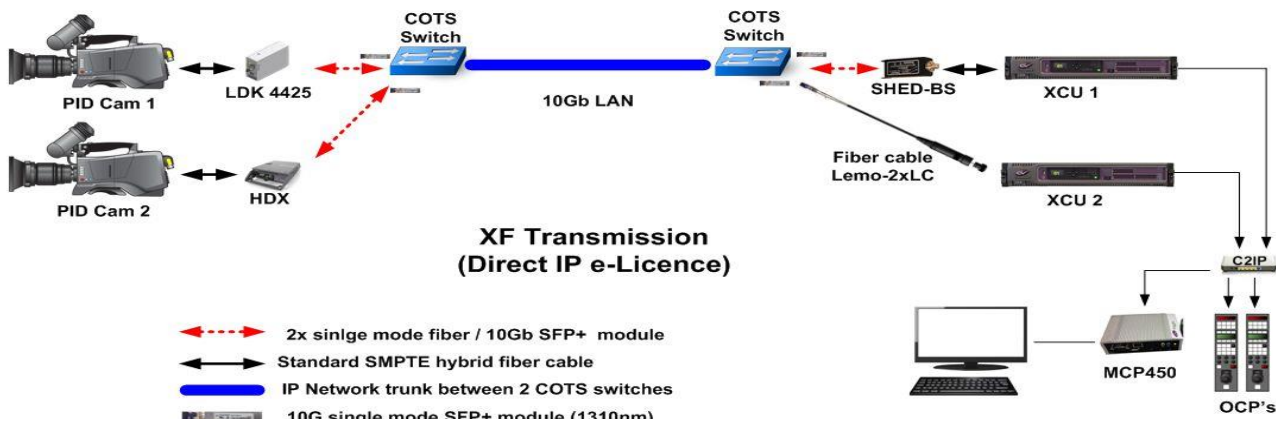
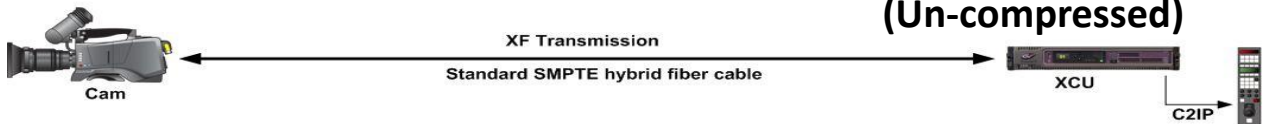

XF Transmission

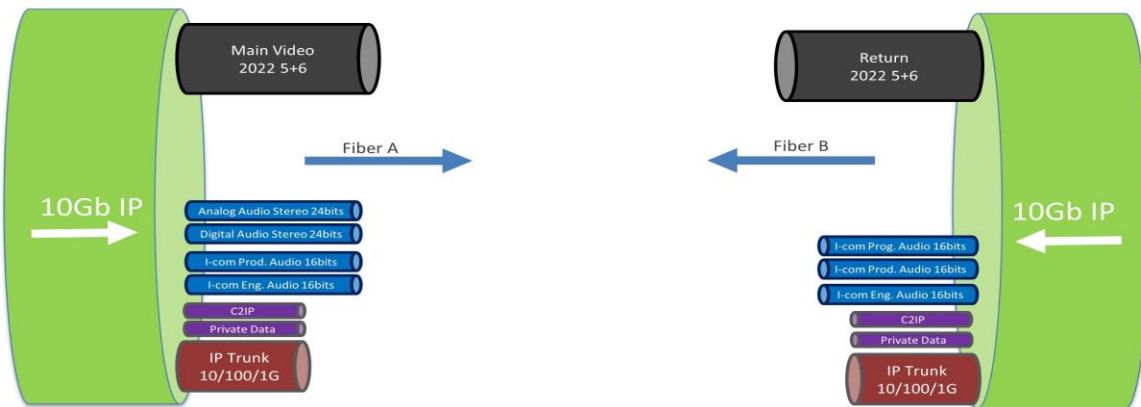

Main ; 1 Channel SMPTE 2022-5+6 1080i50/59 = 1,8Gb
 Return ; 1 Channel SMPTE 2022-5+6 1080i50/59 = 1,8Gb

C2IP + Private Data + I-com + Analog Audio + Digital Audio = ~ 8Mb
 IP Trunk = 0Mb (when not connected)

1080p50/59 = 3,4Gb
 1080i50/59 = 1,8Gb



6,848 -Kilometre LIVE Remote Production (Compressed)

IP SHOWCASE THEATRE AT IBC2019 : 13-17 SEPT 2019



ITN coverage of IAAF World Relays 2019 in Yokohama Japan (Light-compression)

Low Delay IP Optical Transport Networks allowed a successful delivery of Remote Production for IAAF.

Full two days live coverage between Yokohama Japan and NEP Andrews Hub in Sydney Australia.

- 30 high definition (HD) signals,
- 17 where main cameras, of which two Sony HDC4800 cameras in ultra-high frame rate,
- Graphics all done in Yokohama all were linked via diverse and hitless dual 10 gigabit-per-second IP network
- Distributed Production Network (DPN) to Sydney, 7,800km away,
- VC2 ultra-low-latency compression technology.

IP SHOWCASE THEATRE AT IBC2019 : 13-17 SEPT 2019

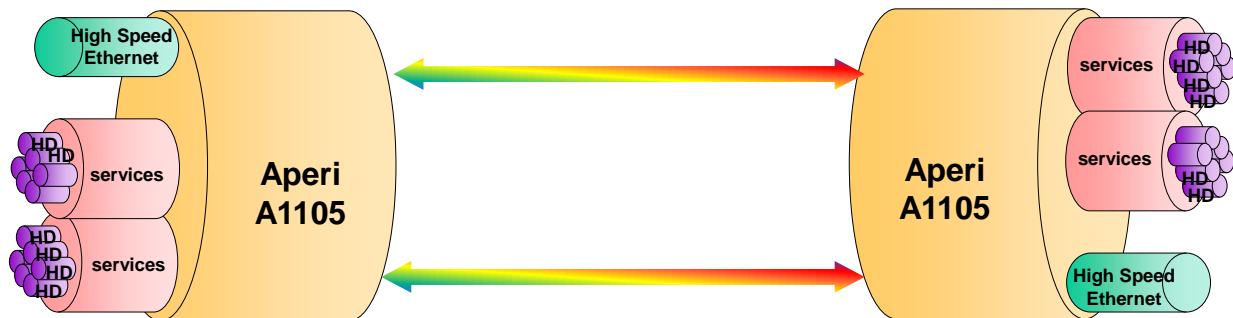

IP SHOWCASE THEATRE AT IBC2019 : 13-17 SEPT 2019



ITN coverage of IAAF World Relays 2019 in Yokohama Japan (Light-compression)

Low Delay IP Optical Transport Networks allowed a successful delivery of Remote Production for IAAF.

Full two days live coverage between Yokohama Japan and NEP Andrews Hub in Sydney Australia.

- 30 high definition (HD) signals,
- 17 where main cameras, of which two Sony HDC4800 cameras in ultra-high frame rate,
- Graphics all done in Yokohama all were linked via diverse and hitless dual 10 gigabit-per-second IP network
- Distributed Production Network (DPN) to Sydney 7,800km away,
- VC 2 ultra-low-latency compression technology.

IP SHOWCASE THEATRE AT IBC2019 : 13-17 SEPT 2019



Transmission Delay

Route	Latency ms	Notes/Cable
Tokyo – London (Westbound via Indian Ocean)	258.1 ms	EAC+SMW5+BH2
Tokyo -- London (Eastbound via USA)	223.056 ms	Measured Latency PoP to PoP RNAL+AAE1 Cable
Tokyo – London (Westbound via Indian Ocean) 2	237.406 ms	Measured Latency PoP to PoP EAC+SMW5 Cable
Tokyo – London (Eastbound via USA)	247.988 ms	Measured Latency PoP to PoP C2C+AJC+ Apollo South Cable
Tokyo – London (Eastbound via USA)	268.0533 ms	Measured Latency PoP to PoP C2C+Unity+ Yellow Cable
Tokyo – Sydney	118.398.00 ms	AJC
Tokyo – Sydney	166.16693 ms	JUS-HAWAII-TEC
LA – Sydney	139.711 ms	TEC-AAG
Sydney-London	280 ms	Asian/Pacific+Atlantic

IP SHOWCASE THEATRE AT IBC2019 : 13–17 SEPT 2019



Jitter

Jitter (IP Packet Delay Variation)

- IP Packet delay variation (IPDV) as defined in ITU-T recommendation Y.1540 is a 2-point metric that measures the difference in IP Transfer Delay (IPTD) of a pair of specified packets in a stream (otherwise known as “Jitter”).
- Measurements for IPDV are performed in accordance with Y.1540 section 6.2.4 – End-to-end 2-point IP packet delay variation. The performance parameters are defined for a set of packets (population of interest), the population of interest to be used must represent a single video flow having the same source, destination and session identification. The minimum IP Transfer Delay (IPTD) is used as the reference delay for all IPDV calculations, as per the ITU’s recommendations.
- Telstra commits to a maximum end-to-end IP packet delay variation of 7 milliseconds in respect of each event. Telstra will measure the IPDV on supported video flows, and does not include Media Data. Measurements will be performed at the points of ingress and egress to Telstra’s network.



IP SHOWCASE THEATRE AT IBC2019 : 13–17 SEPT 2019



Open Transport Network (OTN)

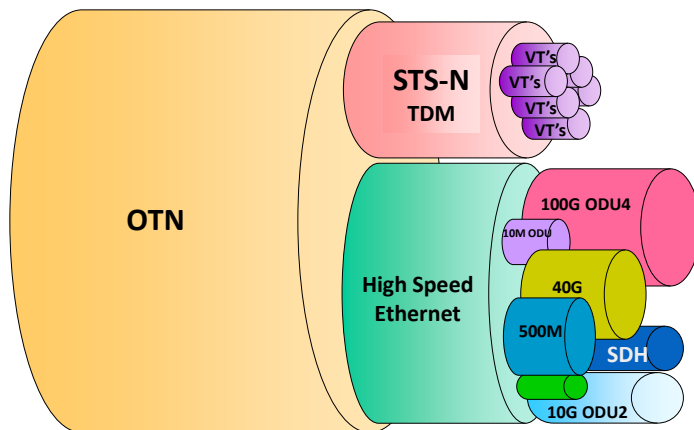

IP SHOWCASE THEATRE AT IBC2019 : 13-17 SEPT 2019



Simpler Multiservice Approach

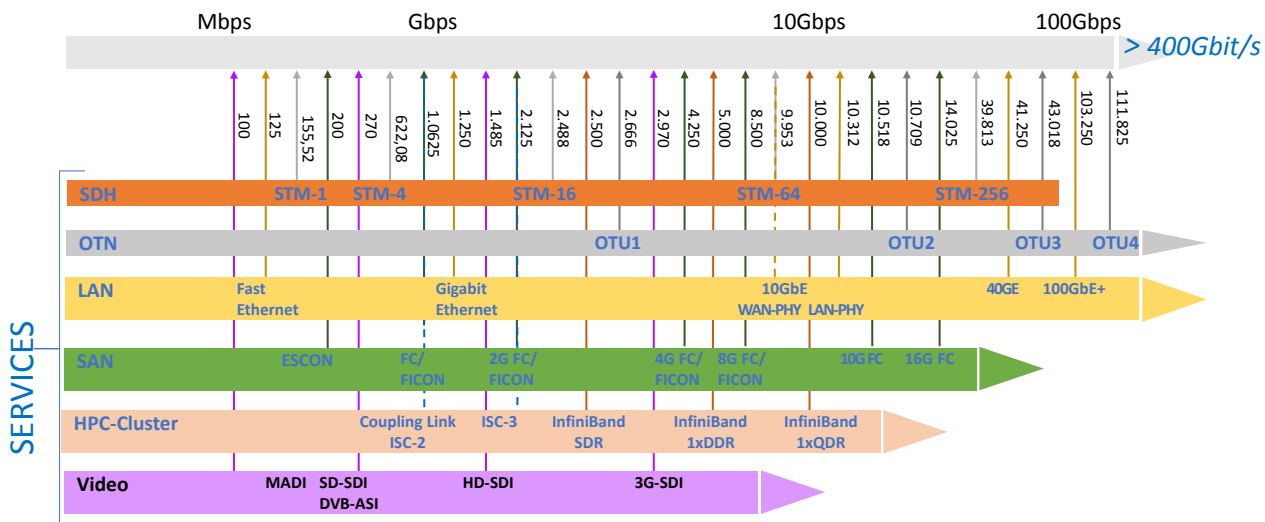

IP SHOWCASE THEATRE AT IBC2019 : 13-17 SEPT 2019



Converged Remote Production



Remote production a converged transport over OTN

Scalability and simplicity addressing the need for reliable remote production networks

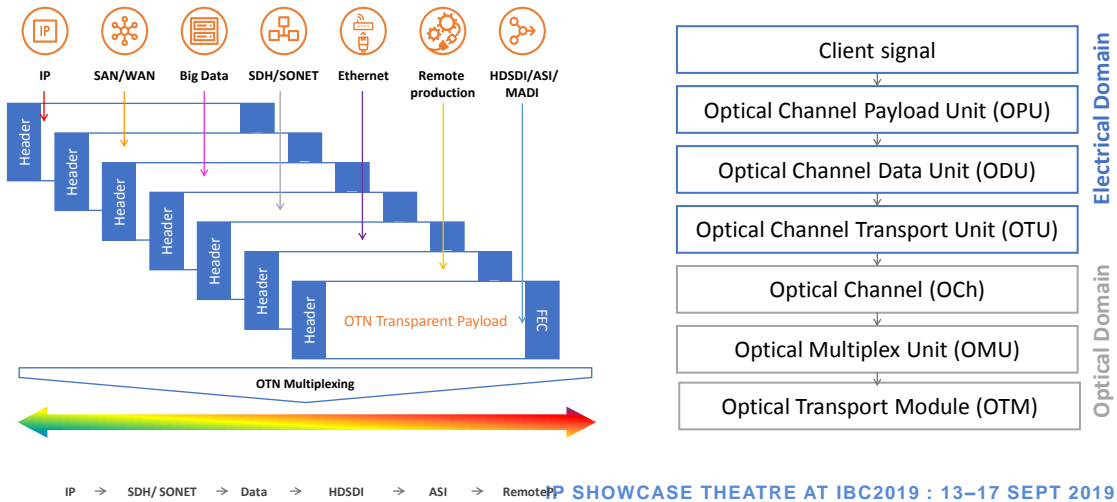

Reference Case Studies



PyeongChang 2018

The Task: Creating a far Stretched World Wide OTN Network to support Rights Holding broadcasters on behalf of the Host.

The Magic: Rights holding broadcasters send their content across Telstra's global fibre network to our Dual and Diverse Meet Me Points of Presence across the extending PyeongChang to Americas, Europe and North America. Telstra supplied high quality OTN low delay network.

The Result: Any Service any Interface and Any Protocol to many Countries. One Cost Effective Next Generation Global Open Transport Network accommodating all Host and RHB requirements.



Women's Tennis Assoc. for Perform Group

The Task: A stated goal was to move as much as possible away from satellite delivery to fibre network delivery, and to limit dependency on SNG services to more IP terrestrial fibre services.

The Magic: Telstra delivered a scenario where they had one partner providing a consistent, reliable end to end content delivery network for all media from all courts from all WTA events around the world.

The Result: Telstra simplified the technology and partnerships required to deliver content for WTA.



Remote production for Fox Sports Australia

The Task: Growing demand for live, high-quality content drives-up operational costs and excessive capital expenditure for broadcasters.

The Magic: Venues broken down by usage into bandwidth allocation high demand sites 50Gbps for near uncompressed workflows, regional 10Gig for smaller less used sites, providing both PoP and Path physical diversity. Telstra delivered a end-to-end IP network.

The Result: More efficiencies, optimisation of technologies, economies of scale. Innovative technology strategy, less resource wastage, accelerated speed to finished product.

IP SHOWCASE THEATRE AT IBC2019 : 13-17 SEPT 2019



OTN Simplicity



Open and simple

Easy to deploy, plug and play, fully transparent



Multi

- Supports wide industry standard transport network interfaces including SMPTE, DVB interfaces
- Metro and efficient long haul transport networks
- Granular BW 100 Mbps to 100 Gbps
- Supports legacy services



Network

- Fully meshed
- High availability, fast protection mechanism
- Resilient fully meshed self healing network



Media transport

- Secured optical encrypted communication for all protocols in particular HDSDI with built in encryption algorithm e.g. GCM-AES-256
- Built in efficient forward error correction suitable for contribution media

IP SHOWCASE THEATRE AT IBC2019 : 13-17 SEPT 2019



Thank you

Carl Petch, Telstra
carl.petch@team.telstra.com
 +61 2 9866 3207

Thank you to our Media Partners



IP SHOWCASE THEATRE AT IBC2019 : 13-17 SEPT 2019 18